

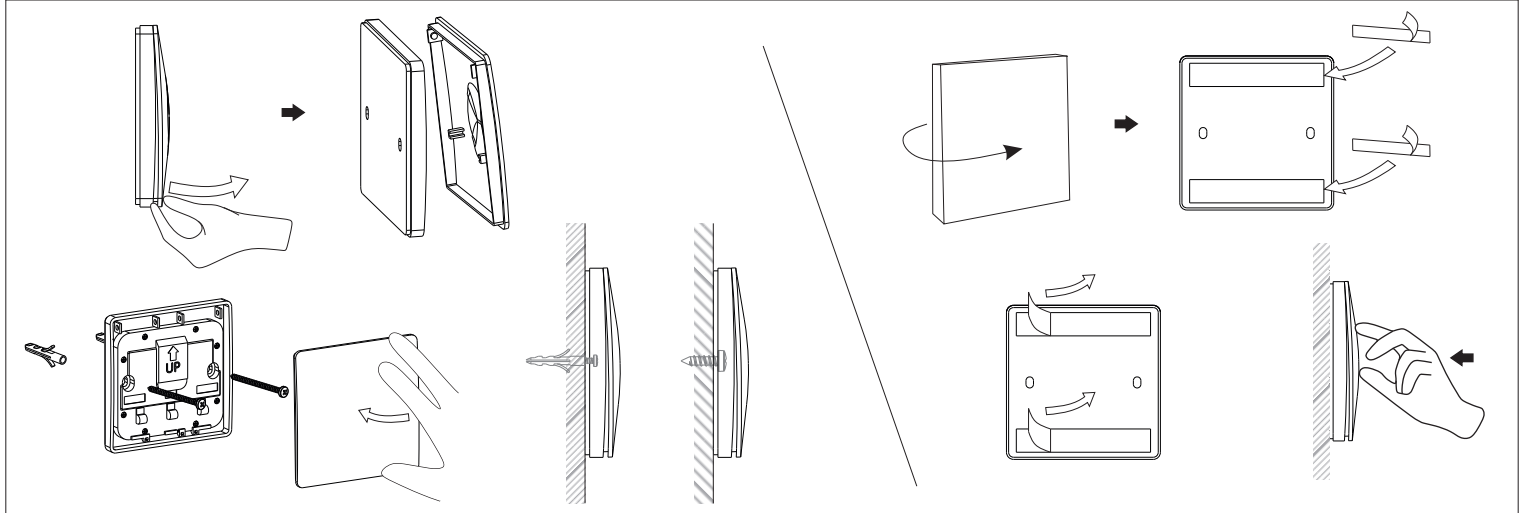

KINY



KINY (D-M)



Remote control matched transmitter:

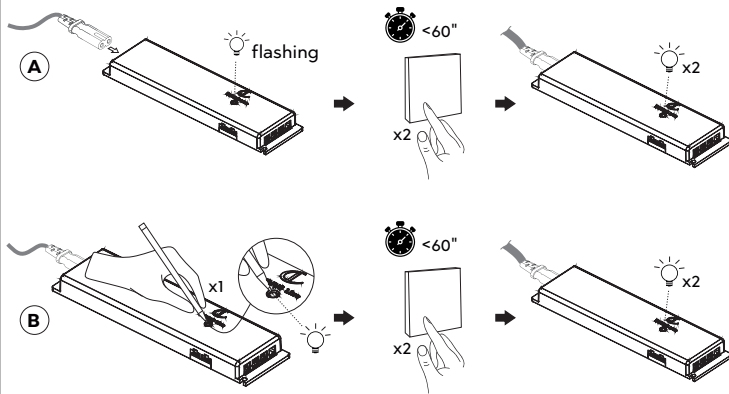

KINY (D-M)



Remote control reset

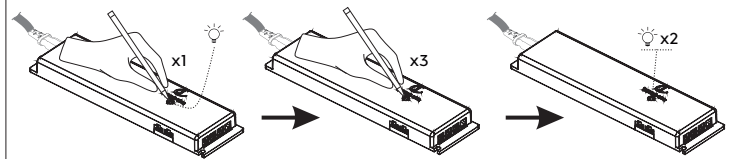

KINY



X-Driver + CM5-XD
Radio receiver for
lighting control

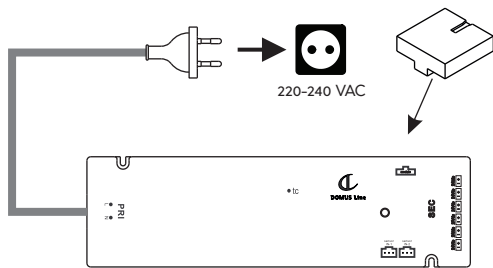

KINY-1/-2/-3
Remote radio emitter
for lighting control
RF 433MHz

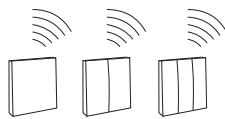

KINY

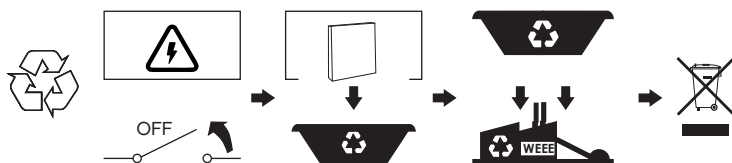
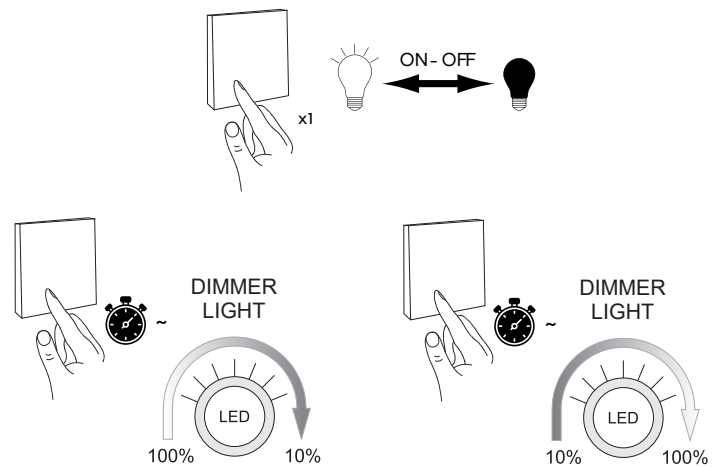

KINY

KINY X-Driver D-M

X-Driver D-M + CM5-XDM
Radio receiver for lighting control

220-240 VAC

KINY-1/-2/-3
Remote radio emitter for lighting control
RF 433MHz

KINY D-M

DIMMER LIGHT

100% 10%

DIMMER LIGHT

10% 100%

KINY D-M: select function

DIMMER LIGHT

100% 10%

DIMMER LIGHT TEMP.

x2

KINY D-M

DIMMER LIGHT TEMP.

x1

DIMMER LIGHT TEMP.

KINY

Match quantity

∞ Infinite

max. 6pcs

OFF

WEEE

KINY

M001100067_r1_p.2/2